



Thule Smart Panels

Thule Sun Blocker G2 - Front Panel

Thule Rain Blocker G2 - Front Panel

> Instructions

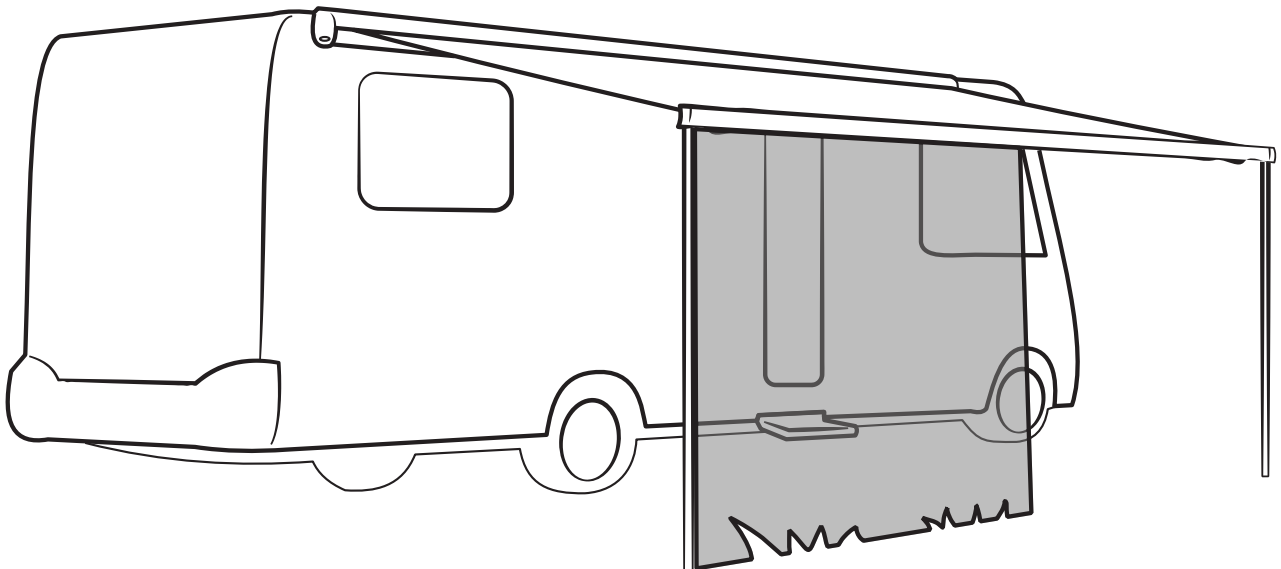

Prod no.: Various

Document: PNL910-02 // 3380038200

Date: 15/11/2018

Bring your life
thule.com



Thule Sun Blocker G2
Front Panel

		A	B	C	D	E	F
Thule Sun Blocker G2 Front Panel	1.00m	2	2	2	2	-	-
	2.40m ~ 2.80m	4	4	4	4	-	-
	3.30m ~ +	5	5	5	5	-	-



Thule Rain Blocker G2
Front Panel

Thule Rain Blocker G2 Front Panel	1.00m	3	2	2	-	2	2
	1.25m ~ +	4	3	3	-	3	2



Thule Sun Blocker G2 - Front Panel

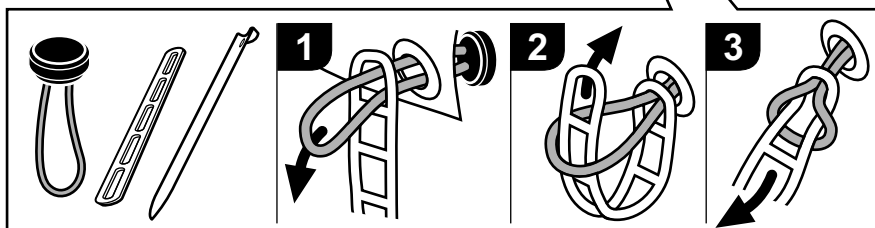
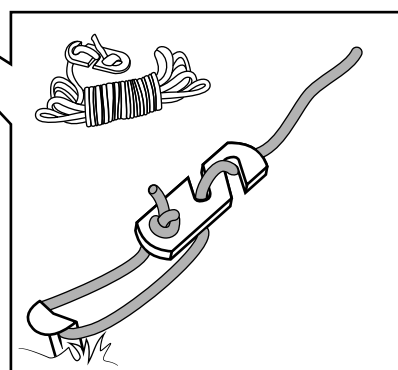
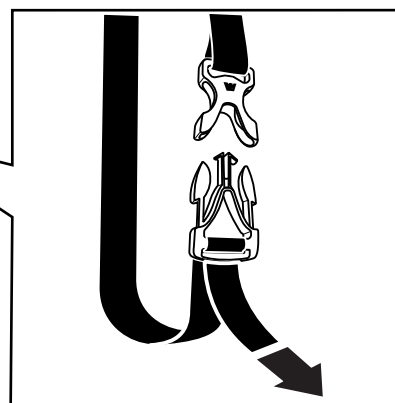
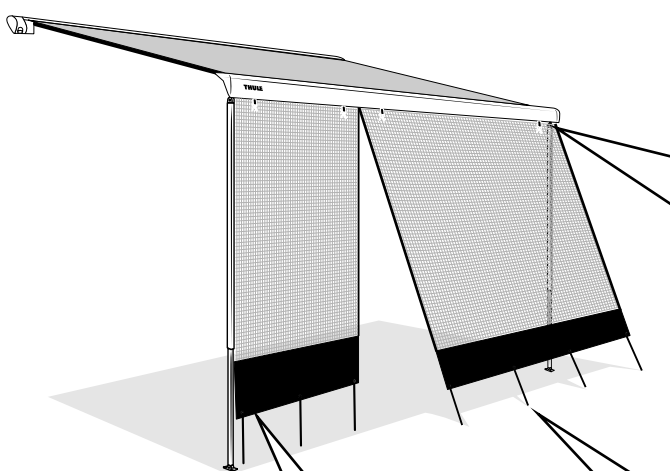
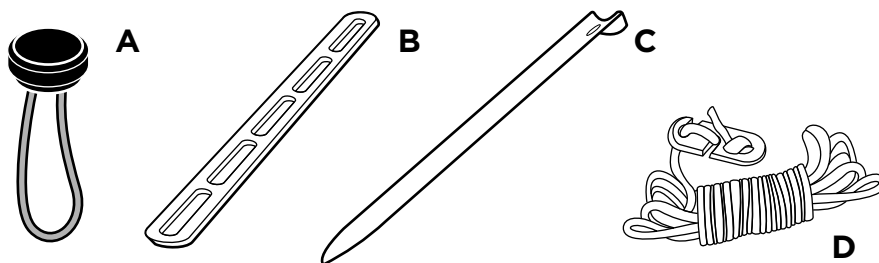
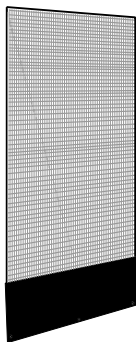
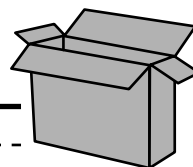



Thule Rain Blocker G2 - Front Panel

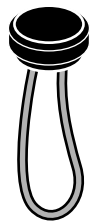
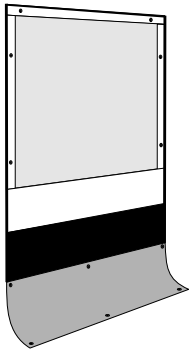
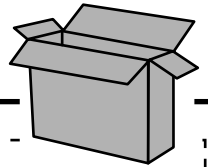

A

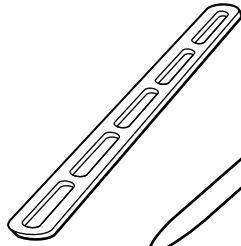

B

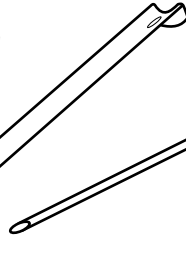

C



E



F

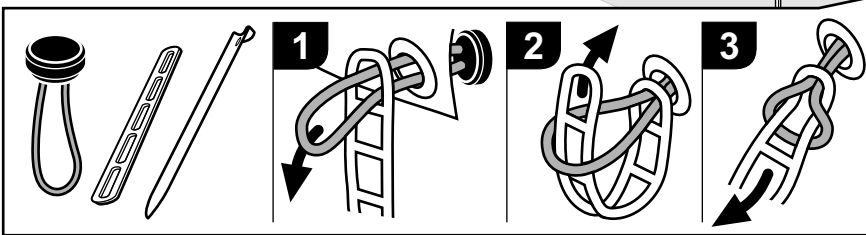
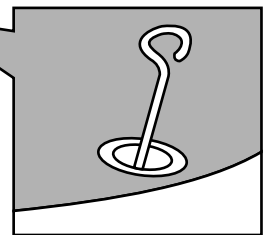
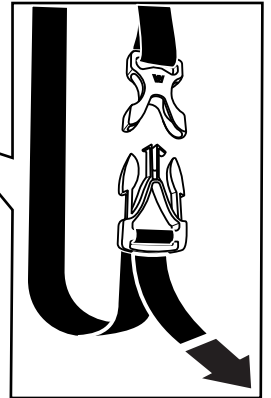
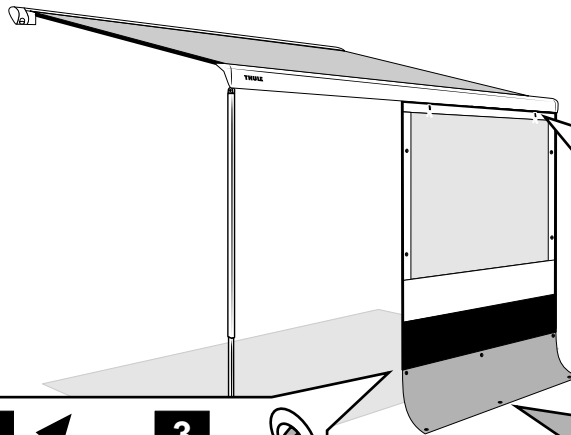

i

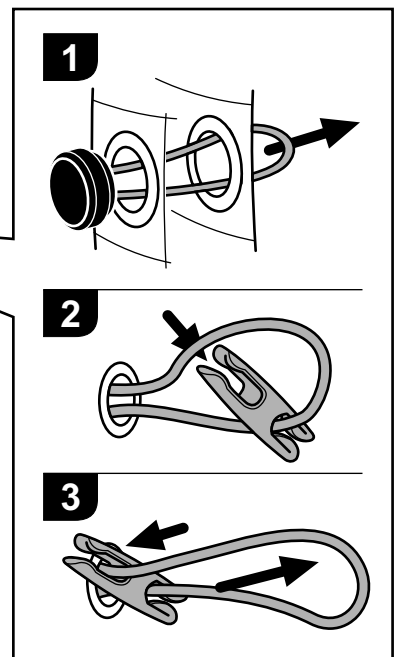
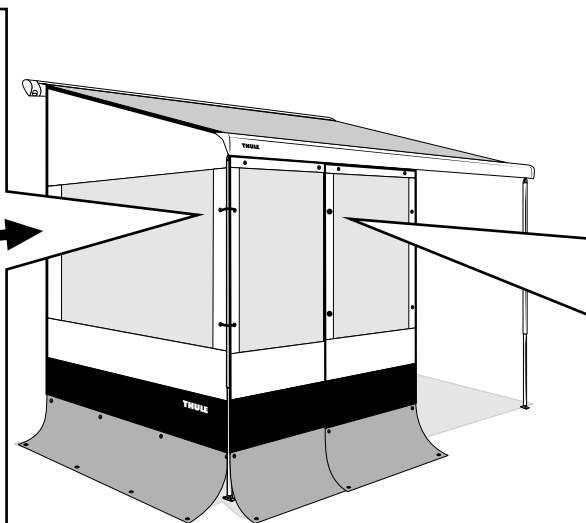
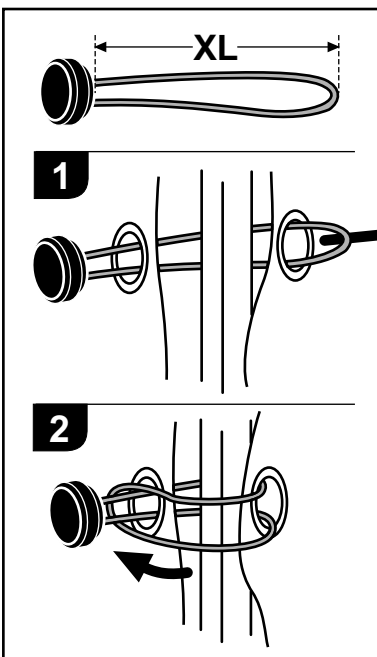

Smart Panels

Some possible combinations

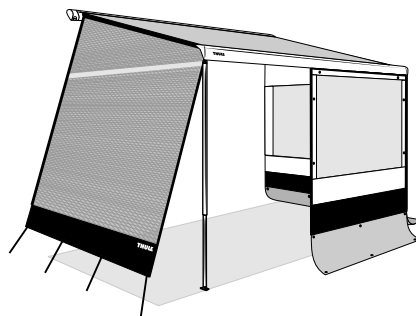
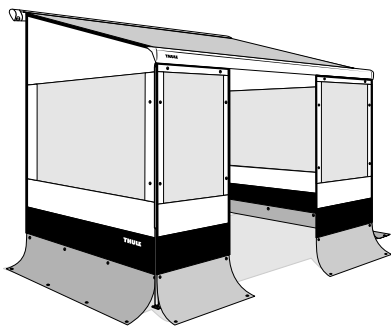
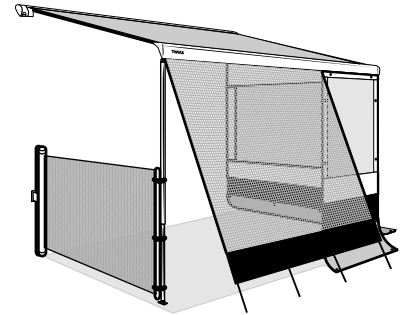
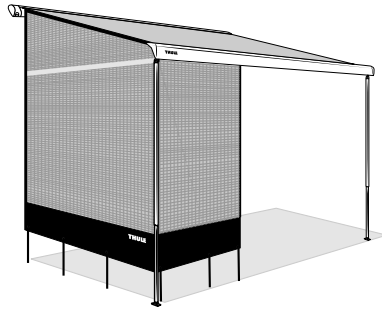
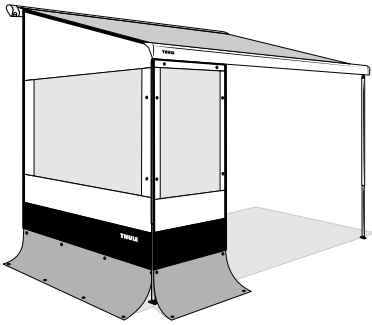

306456

Thule Windscreen

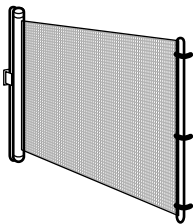

Tent

Thule QuickFit

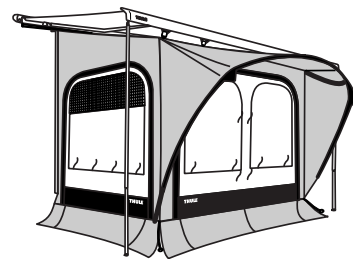

Front

Thule Sun Blocker G2
Thule Rain Blocker G2

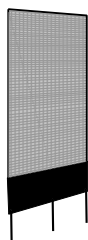
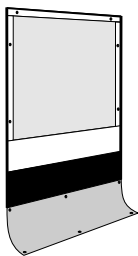

Side

Thule Sun Blocker G2
Thule Rain Blocker G2
Thule View Blocker G2

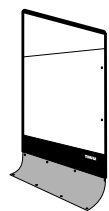
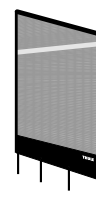

Thule Rain Blocker Front G2

Available models

MINIVAN

A

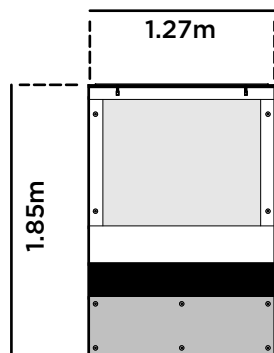

306454

S / TO1200 V2

B

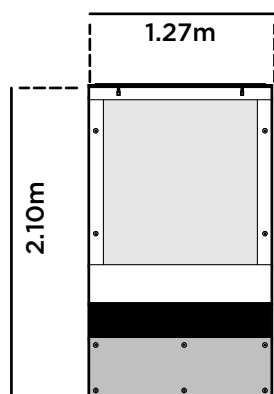

301320

C

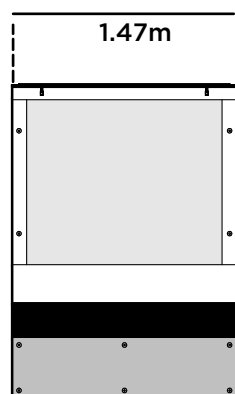

301321

D

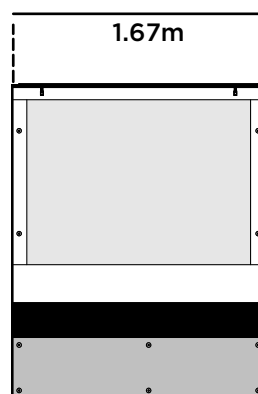

301322

E

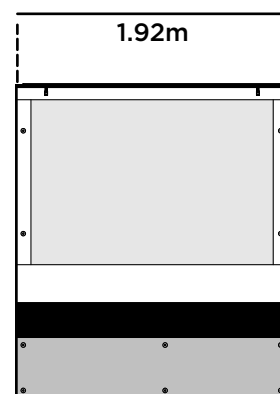

301323

M / L / XL / XXL / VAN

F

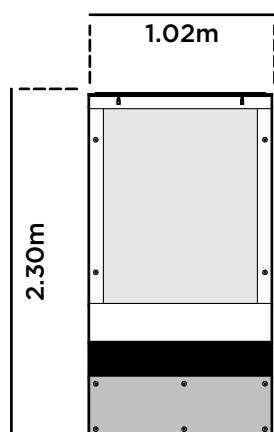

307303

G

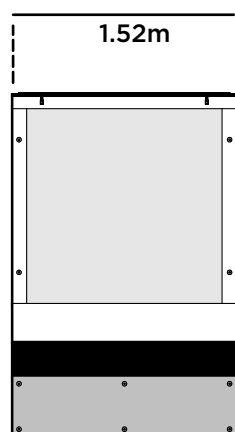

307304

H

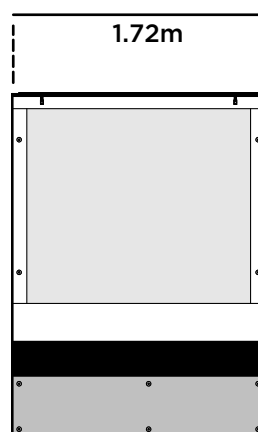

307305

I

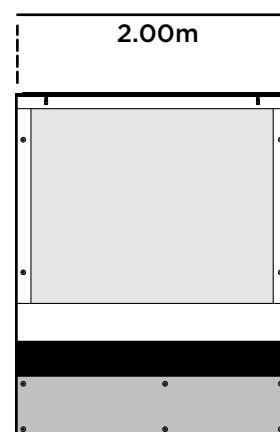

307306

Thule Rain Blocker Front G2

Combinations for full awning length

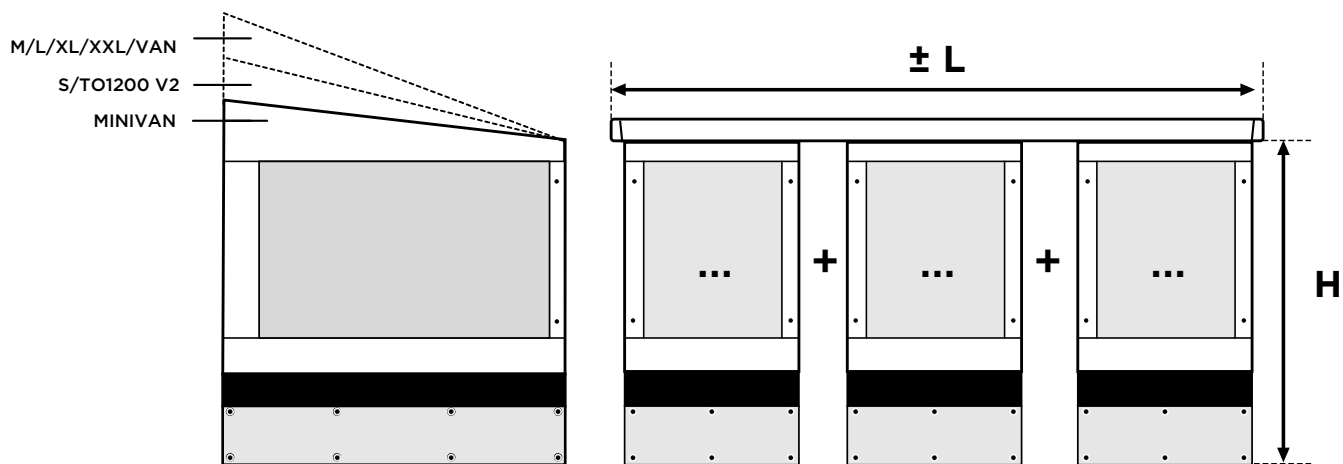

COMPATIBLE SIDE PANEL	AWNING LENGTH (L)	FRONT COMBINATION
MINIVAN	2.60m	A + A
S TO 1200 V2	2.60m	B + B
	2.80m	B + C
	3.00m	B + D
	3.25m	B + E
	3.50m	C + E
	3.75m	D + E
	4.00m	E + E
	4.25m	B + C + C
	4.50m	C + C + C
	5.00m	D + D + D
	5.50m	D + E + E
M L XL XXL VAN	3.00m	F + F + F
	3.25m	G + H
	3.50m	F + G + F
	3.75m	H + I
	4.00m	F + I + F
	4.25m	F + G + H
	4.50m	F + I + G
	5.00m	G + I + G
	5.50m	I + G + I
	6.00m	I + I + I

EN

Read the instructions carefully. Wrong installation, use or repair voided warranty. If recovery is needed, consult a dealer.

General remarks

- The amount of combinable panels depends on the awning type. Consult a dealer for further details.
- The sun can affect colors depending on usage.
- When it rains, put one side of the awning lower so that the water can drain.
- When wind reaches 6 Bft. please store the panels and close the awning.
- Don't place heat sources near the walls or the roof.

Maintenance

- Ensure that there are no hard objects on the window during folding. This is to prevent impressions.
 - Let the panel dry thoroughly before long time storage.
 - Use pure water or a dry brush to clean the panel.
-

NL

Lees deze montage instructies aandachtig. Bij verkeerde montage, gebruik of eigenhandig herstel vervalt elke aanspraak op garantie. Indien herstel nodig is, raadpleeg een dealer.

Algemene opmerkingen

- Het aantal panelen dat men kan combineren is afhankelijk van de luifel. Raadpleeg een dealer voor meer details.
- De zon kan kleuren aantasten afhankelijk van het gebruik.
- Zet bij regen één kant van de luifel wat lager zodat het water kan aflopen.
- Vanaf windkracht 6 Bft. gelieve de panelen op te bergen en uw luifel te sluiten.
- Geen warmtebronnen in de buurt van de wanden of het dak plaatsen.

Onderhoud

- Zorg ervoor dat er geen harde voorwerpen op de ruit liggen tijdens het opvouwen. Dit om afdrucken te voorkomen.
 - Laat de panelen goed drogen alvorens op te bergen voor langere tijd.
 - Gebruik zuiver water of een droge borstel om de panelen te reinigen.
-

DE

Bitte lesen Sie die Montagevorschriften gründlich durch. Beiverkehrter Montage oder Änderung des Produkts entfallen alle Garantieansprüche. Im Falle von Reparaturen wenden Sie sich bitte an Ihren Fachhändler.

Allgemeine Bemerkungen

- Die Anzahl der Thule Smart Blocker Modelle die kombiniert werden können, sind abhängig von der Markise. Bitte kontaktieren Sie für mehr Details Ihren Händler.
- Die Sonne kann Farben beeinflussen je nach Gebrauch
- Stellen Sie die Markise schräg für einen besseren Wasserablauf.
- Ab Windstärke 6 : das Produkt abbauen und die Markise einfahren.
- Keine Wärmequellen in der Nähe der Wände oder das Dach setzen.

Unterhalt

- Vermeiden Sie beim Falten dass sich keine harten Gegenstände oder Schmutz mit einrollen. Es kann Abdrücke verursachen auf die Fensterfolie.
 - Lassen Sie den Wand gut austrocknen vor dem zusammenfalten für längere Zeit.
 - Benützen Sie nur sauberes Wasser und eine trockene weiche Bürste um das Produkt zu reinigen.
-

FR

Lisez attentivement les notices d'installation. Une mauvaise installation, utilisation ou propre réparation annule toute garantie. Si la réparation est nécessaire veuillez consulter votre revendeur.

Remarques générales

- Les différentes combinaisons de panneaux dépendent de la longueur du store. Veuillez consulter votre revendeur pour plus d'informations.
- Dépendant de l'utilisation le soleil peut affecter le coloris de la toile
- Abaissez un pied de store pour obtenir un meilleur écoulement de l'eau en cas de pluie.
- À partir d'une force de vent de 6 Bft démontez le panneau et fermez le store.
- Ne placez aucune source de chaleur près des murs ou du toit.

Maintenance

- Assurez-vous qu'il n'y a pas d'objets extérieurs sur la fenêtre lors du repliage. Ceci afin d'éviter des encoches dans la toile.
- Laissez sécher la toile complètement avant de la ranger de longue durée.
- Utilisez de l'eau claire ou une brosse sèche pour nettoyer.

